

Sta-Rite™ Aluminum Signpost

78" Aluminum Signpost

- Complete with two (2) brackets and required bracket hardware.
- Post black cap is included.
- Supports signs up to:
 - Aluminum 12" x 18"
 - HDPE up to 18" x 24"

Illustrated P/N Example:

S	T	R	0	-	7	8	0	F
---	---	---	---	---	---	---	---	---

1	Bollard
0	none
B	Bollard Enhanced
2,3	Height
60	60"
78	78"
02	102"
4	Panel Type
0	none
H	Handicap
S	24" Stop
V	Van Accessible, Handicap
Z	Custom
5	Base Socket Type
D	Drivable Spring Adapter (Square, No Tube included)
F	Fixed Surface Mount Spring Adapter (No Base included)
Q	Quick Release Surface Mount Spring Adapter (No Base included)

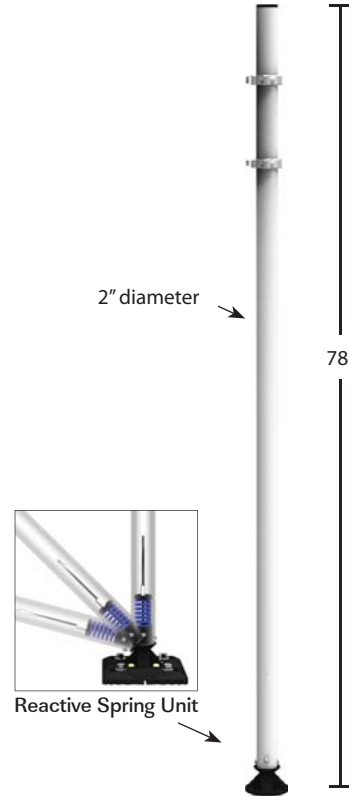

BASE OPTIONS

Surface Mount Fixed Base

P/N: BS-SMFB
Color Options: Black, White, Yellow



Drivable Base

2" - 12 Gauge Square Tube
P/N: BS-DR00

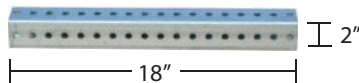

Surface Mount Quick Release Base

P/N: BS-SMQB
Color Options: Black, White, Yellow



SPECIFICATIONS

- Post is constructed of white powder coated aluminum to prevent warping and remain straight.
- Unit has a reactive spring assembly that allows the signpost to be bumped by vehicles, rebound, and return upright.

RECOMMENDED USES

- For permanent use within parking lots and parking garages.
- Asphalt, concrete, or in-ground installation
- Use where occasional bumping by vehicles can damage traditional signposts causing costly repairs or replacement.