

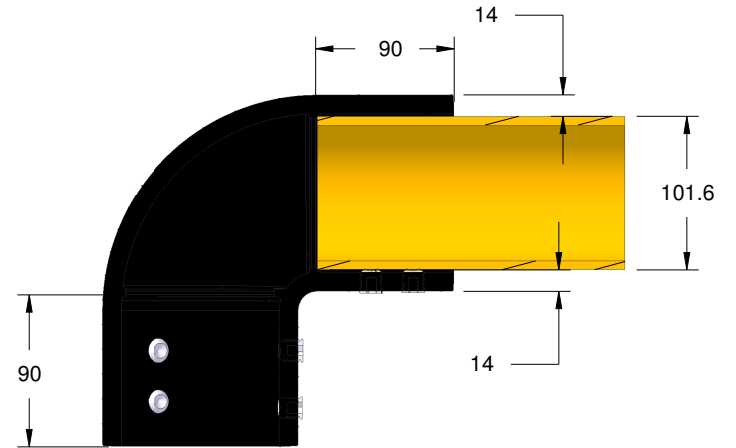

PIPE SHOWN FOR REFERENCE

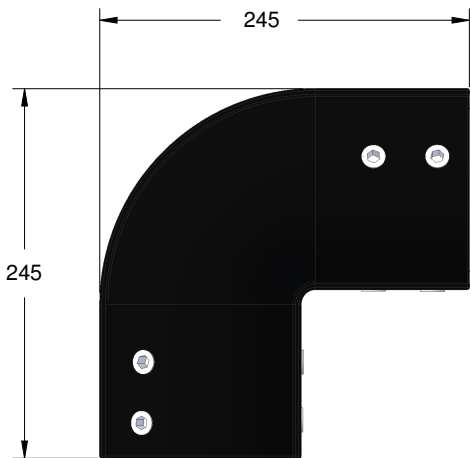

Section A-A

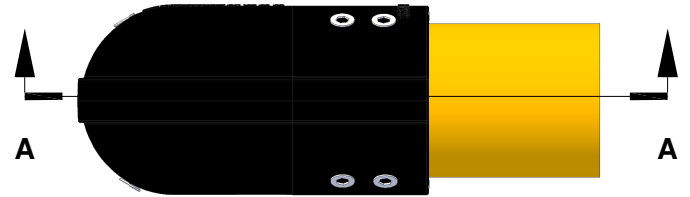

CONFIDENTIAL & PROPRIETARY

The drawing on this print and the information therewith are property of SlowStop Guarding Systems, LLC, and shall not be used or discussed in whole or in part without the consent of SlowStop Guarding Systems, LLC.

4955 STOUT DR. · SAN ANTONIO, TX 78219 · (800) 736-5256

SIZE
A

PART NO.
SS-T2-ELBOW

DWG.
IRONFLEX TYPE 2 ELBOW CONNECTOR

REV
1.0

SCALE

SLOWSTOP GUARDING SYSTEMS, LLC

DATE 14-AUG-2017